

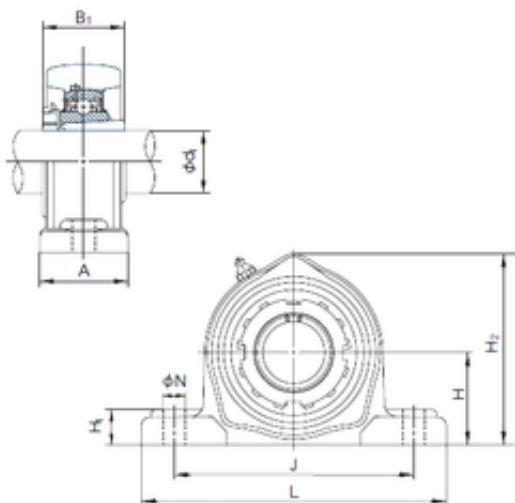

BEARING PRECISION AXLE CORP.

NACHI UKPK213+H2313 Bearing units

Bearing No. UKPK213+H2313



UKPK213+H2313 Bearing 2D drawings and 3D CAD models

Bore Diameter	60 mm
d	60 mm
H	76.2 mm
A	70 mm
B1	65 mm
H1	27 mm
H2	156 mm
J	203 mm
L	258 mm
N	24 mm
Bolt (G)	M20