

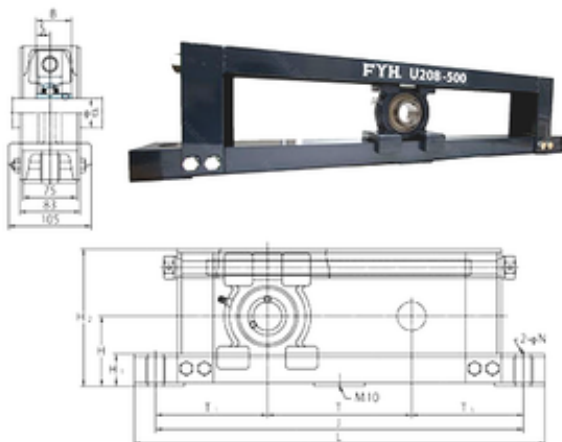

BEARING PRECISION AXLE CORP.

FYH UCTU316-800 Bearing units

Bearing No. UCTU316-800



UCTU316-800 Bearing 2D drawings and 3D CAD models

Bore Diameter	80 mm
Width	86 mm
d	80 mm
T1	220 mm
B	86 mm
H	160 mm
H1	55 mm
H2	315 mm
J	1240 mm
L	1300 mm
N	22 mm
S	34 mm
T	800 mm
Bolt (G)	M18
Weight	64 Kg
Basic dynamic load rating (C)	123 kN
Basic static load rating (C0)	86,7 kN